

Directive Systems & Engineering

2702 Rodgers Terrace
Haymarket, VA 20169-1628

www.directivesystems.com

703-754-3876

12 Element 2.5 wl. K1FO Designed Yagi, Model DSEFO144-12

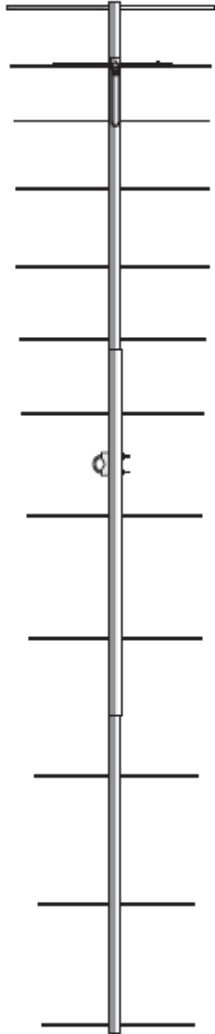

ELECTRICAL SPECIFICATIONS

Frequency range: MHz 144-146
 Gain: dBd..... 12.6
 Impedance: Ohms..... 50
 Connector type..... Type N(F) UG-58/U
 Front -to- back ratio: dB..... 23
 SWR: Typical at resonance..... $\cong 1.2:1$
 Beamwidth: degrees
 E- Plane 34°
 H- Plane 37°
 Sidelobe level: decibels
 E- Plane -19
 H- Plane -16
 Power rating, Continuous: Watts 1000
 Stacking Distance: ft.(m)
 E- Plane..... 11'7" (3.53)
 H- Plane..... 10'8" (3.25)

MECHANICAL SPECIFICATIONS

Boom length: ft. (m.)..... 17'4" (5.28)
 Turning radius: in. (m.)..... 10'4" (3.15)
 Weight Assembled: Lbs (kg.)..... 9.5 (4.32)
 Max mast size: in. (cm.)..... 2" (5.08)
 Wind surface area: Ft (m.) 1.5 (.14)
 Wind Survival: Mph (km/hr)..... 100 (160)

PARTS LIST

Note: All hardware is Stainless Steel, unless otherwise noted.

Boom

1 1/4" Rear Boom section	1 (match colors)
1 3/8" Center Boom section	1 (match colors)
1 1/4" Front Boom section	1 (match colors)

Element Bundle

1/4" Elements	11
1/2" Driven Element	1
3/8" T-arms	2

Hardware Bag		Boom-to-Mast Hardware	
T-arm Shorting Bars	2	1/4" x 1 3/4" U-bolts	2
8-32 x 1 1/4" Machine screw	4	1/4" Nuts	4
8-32 x 1 3/4" Machine screw	2	1/4" Split Lock washers	4
8-32 x 1 3/8" Machine screw	1	1/4" Flat washers	4
#8 Internal Tooth Lock washers	2	5/16" x 2" U-bolts	2
#8 Split Lock washers	6	5/16" Nuts	4
#8 Nuts	8	5/16" Split Lock washers	4
6-32 x 1/2" Machine screw	2	5/16" Flat washers	4
#6 Internal Tooth Lock washer	5		
T-arm support bracket (pre-assembled with Delrin standoffs)	1	Prepared Balun	1
1/4" Element insulators	23	Boom to Mast plate	1
1/4" Keepers	24	Anti-Seize Compound	1
3/8" Hole plug	1	Element assembly tool	1
1/2" End caps	2		
3/8" End caps	2	Assembly Manual	1
1 1/8" Boom End Caps	2		
1 1/2" Hose Clamps	2		
Prepared Female Type-N connector	1		
Cable ties	3		

Anti-Seize Compound - Apply a small amount of the supplied Anti-Seize Compound to the aluminum joints and to the threads of the U-Bolts to prevent galling.

CAUTION: *While we strive to remove all burrs from all machined parts, there is always the possibility of sharp edges. We strongly suggest checking the edges and use a fine file, or 400 grit sandpaper, to remove any burrs that may have been left.*

Tools needed: #2 Phillips screwdriver
 1/4" flat blade screwdriver
 large needle nosed pliers
 keeper installation tool (supplied with kit)
 ruler with metric millimeter markings
 marking pencil

BEFORE INSTALLING YOUR NEW ANTENNA, PLEASE BE SURE TO READ THE ENCLOSED WARNING PAMPHLET.

ASSEMBLY INSTRUCTIONS

1) The antenna components should be removed carefully from the shipping container and the individual parts counted and checked for completeness. Be careful to check all tubing pieces for elements and hardware that may be packed inside.

In the following steps, apply a small amount of the supplied Anti-Seize to the boom joints:

2) The boom consists of three pieces of tubing. The rear boom section has the large hole for the driven element in it. The larger diameter center boom section (1 3/8" dia.) must be connected to the rear section. Insert rear section where marked with like colors, align the #8 hardware mounting holes and slide the stainless steel worm clamp over the slotted portion of the center boom piece. An 8-32 X1 3/4" machine screw, lock washer and hex nut complete the process. Tighten all hardware then proceed with the front boom piece. That connection with the mid boom piece is also marked with like colors. Similarly attach the front boom section as you did the rear.

3) The element bundle contains all of the elements needed for assembly. Take time to inventory each one and check off each dimension with Table 1. Some elements vary by 1 or 2mm in overall length, so extreme care in measuring is called for here. Arrange elements in order of descending size and mark each element with a scribe for proper location of the "keeper" (See Table 1 and Figure 1). The reflector is the longest element, and each succeeding director is slightly shorter. DIR # 10 is the shortest. The keeper must be installed as shown in Fig. 2. Using the aluminum tubing tool supplied, slide the keeper to within 1/8" or 3mm of the scribed line. Final adjustment will be done on the antenna. Note that the keeper is a one-way device only. If you go past the scribed line, you must continue to the element end and start the process over. Place the first keeper on all elements.



FIGURE 1.

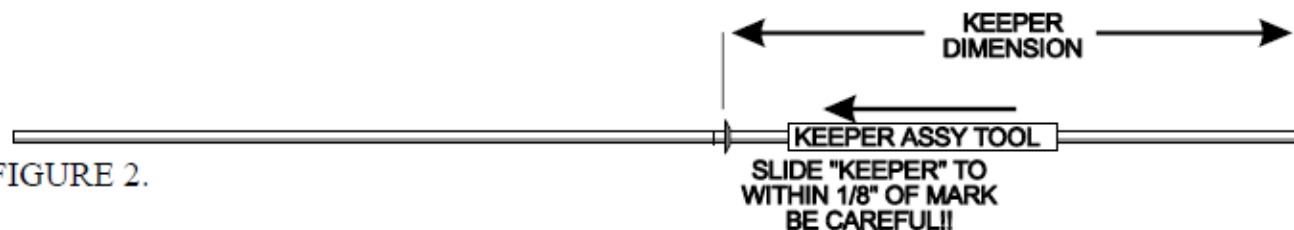

FIGURE 2.

4) You are now ready to install the elements on the boom. You must start at one end and work your way, in order, to the far end of the boom. Lay out the elements in ascending or descending order as appropriate. Install a black insulator in each side of the boom piece at the starting end, and slide the correct element through the two insulators. Obtain a second keeper and install that keeper on the opposite end of element #1 from the pre-installed keeper.

(See Figure 3) Check that the element is centered before you snug up both keepers. A positioning error of +/- 2mm or 0.080" is acceptable.

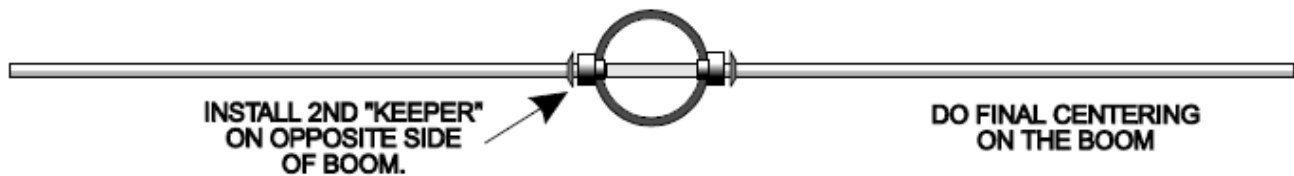

FIGURE 3.

5) At this point, if you tighten the keepers and the element is not centered, you will have to cut one of the keepers to remove the element and start again. Some extra keepers are supplied, but care is definitely required here. Check your work as you go! Proceed with the next element in similar fashion. Check off each element on Table 1 to monitor your progress. Double-check element lengths one last time before final installation on the boom.

6) The driven element is next. Refer to the drawing in Figure 4 and the photos in Figure 5 for guidance. The driven element slides through the boom at the 1/2" holes. It should slide through with some friction and you might need to twist it back and forth to get it through. Align the hole in the driven element with the hole in the boom. Insert an 8-32 X 1 3/4" screw through the large hole in the bottom of the boom, through the driven element and up through the hole in the boom. Place the T-arm support bracket on next, then the connector L bracket (connector facing forward!). Next place a #8 internal tooth lock washer and a nut and tighten. Install 3/8" plastic plug in the driven element access hole.

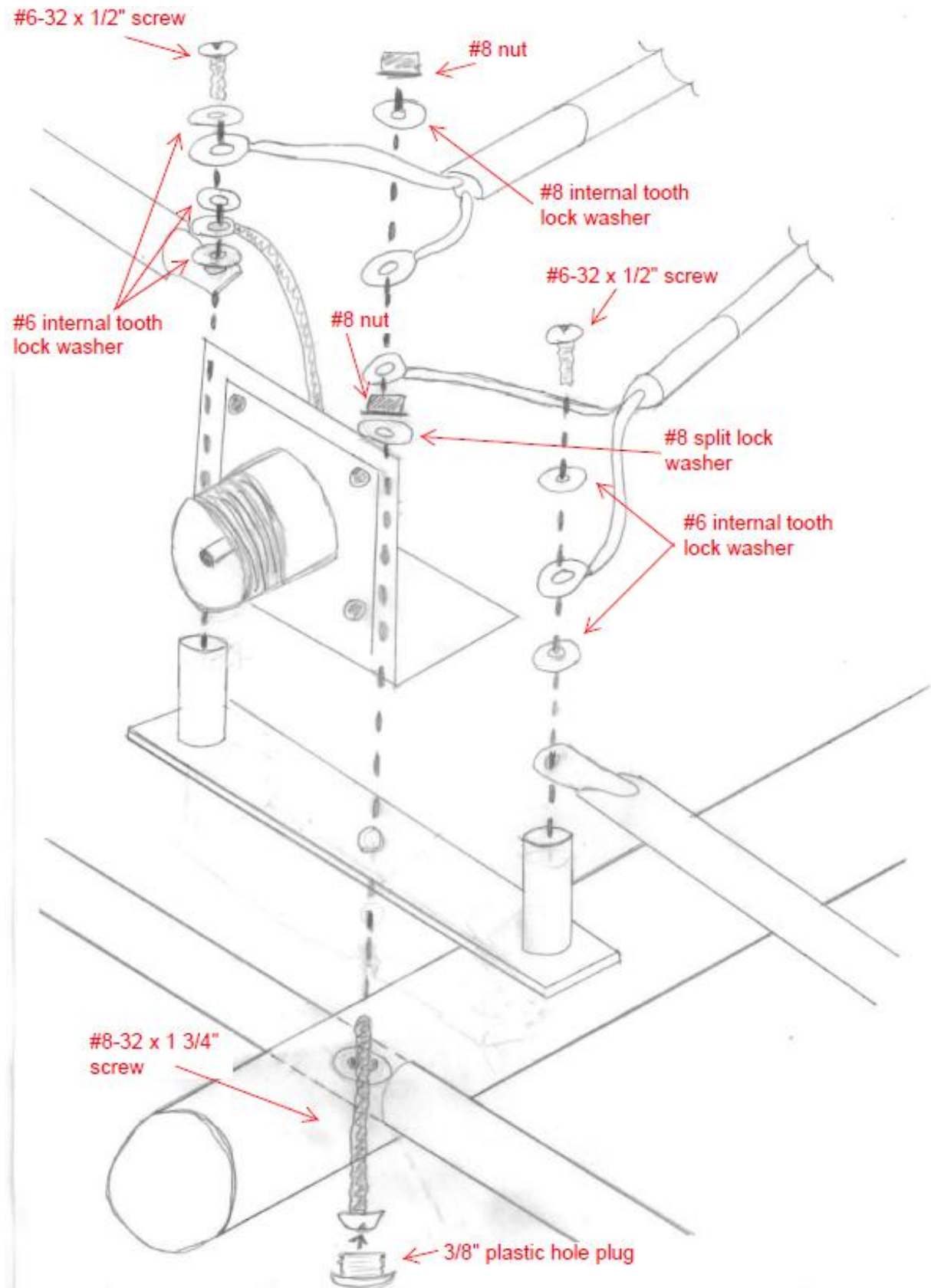
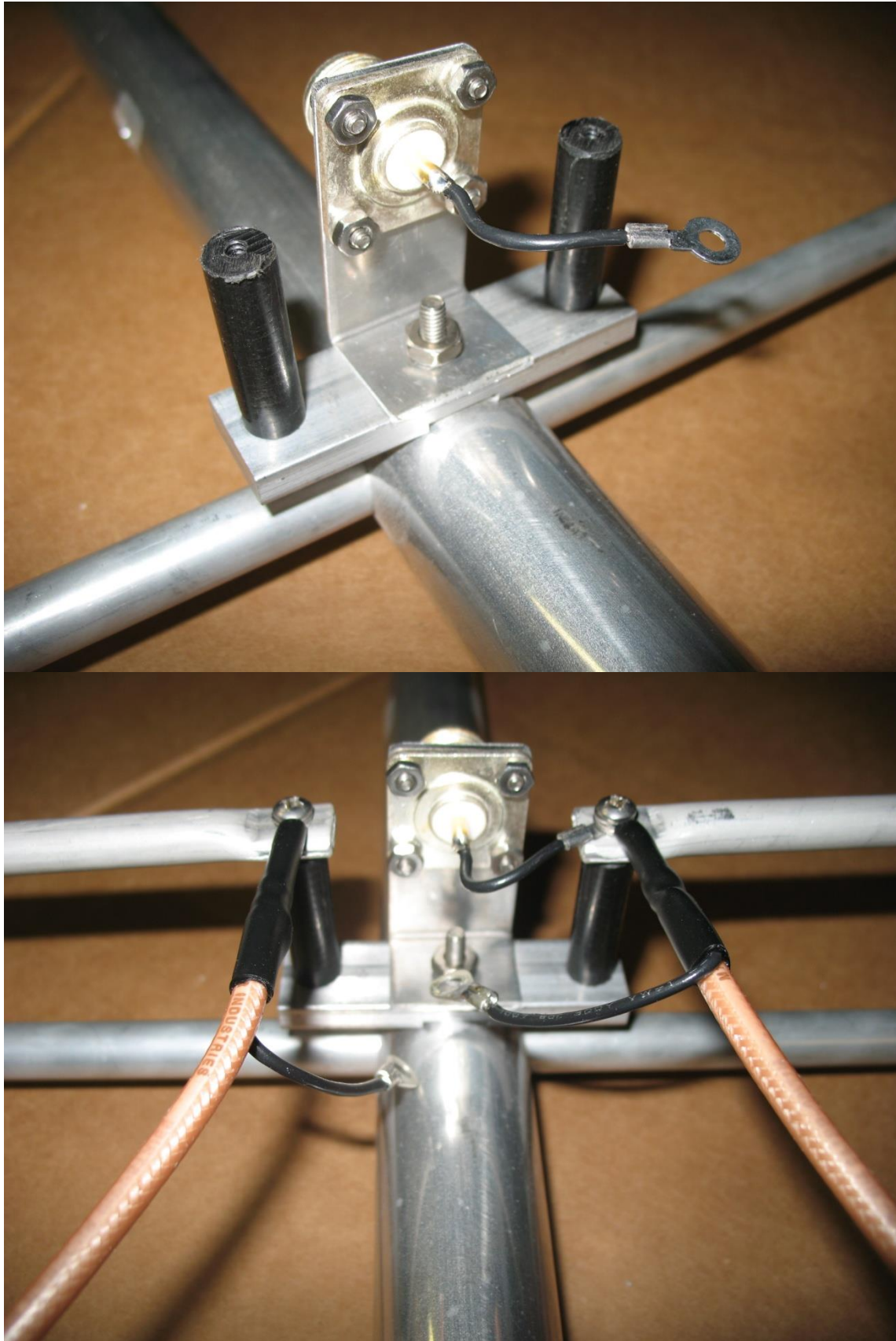
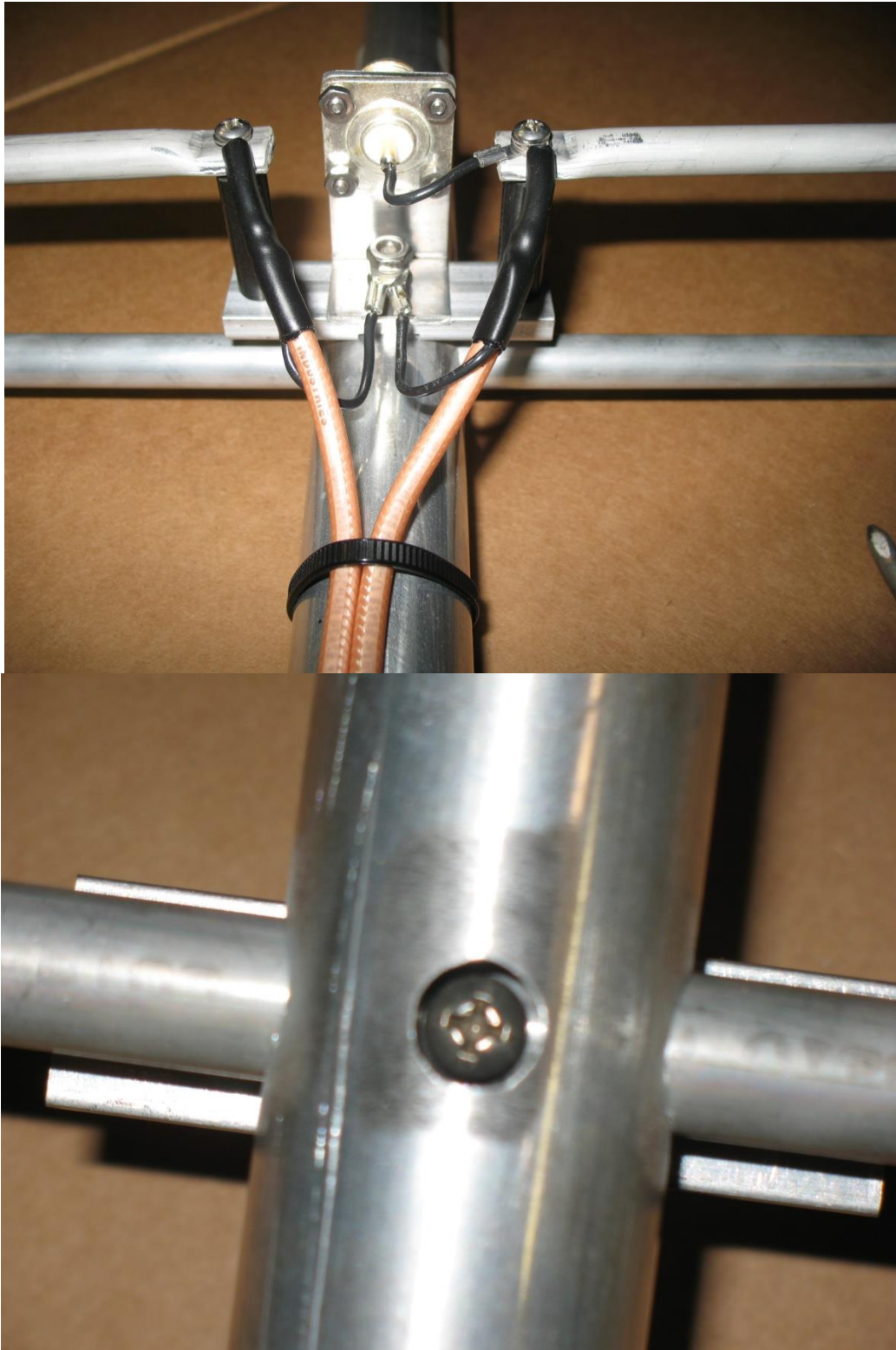

FIGURE 4.





FIGURES 5.

If you are installing multiple antennas, please be sure that you build each antenna with the same T-match wire orientation. In the above drawing, the center pin goes to the right hand side of the antenna as viewed from the back of the connector. Make sure both antennas do the same! Proper phase relationship is very important here!

- 7) Next is the T-Match assembly. Once again, refer to figure 4 and 5. Starting with the left T-arm, viewed from the rear, pass a 6-32 X 1/2" screw through a #6 internal tooth lock washer and through a lug on the center conductor of the balun through a second # 6 internal tooth lock washer, through the T-arm and into the insulator. Do not over-tighten the screw as the threads of the insulator can be easily damaged. The right side is next. Pass a 6-32 X 1/2" screw through a #6 internal tooth lock washer, then the center conductor of the balun, another #6 internal tooth lock washer, the lug from the N connector, another #6 internal tooth lock washer, the T-arm and screw into the insulator.
- 8) Place a #8 internal tooth lock washer on the screw securing the driven element and the T-arm support bracket, then the two ground lugs from the balun, then another #8 internal tooth lock washer and nut. Tighten securely.
- 9) Last, pass 8-32 X 1 1/4" screws through the holes in the shorting bars and place a split lock washer and nut on the other end. Slide the shorting bars over the ends of the driven elements and over the T arms and measure from the T arm mounting screws to the inside edge of the shorting bars and set it at 160 mm.



FIGURE 6.

10) Using supplied cable ties, secure the balun to the boom exactly as shown in Figure 6 and route so they do not touch any of the elements; this will ensure minimum SWR. Install supplied 1 1/8" plastic caps on ends of boom.

Before moving on to the following step, apply a small amount of the supplied Anti-Seize Compound to the threads of the U-Bolts to prevent galling:

11) Attach the boom to mast plate to the boom midway between elements D-5 and D-6. Use the 1/4" U-bolts with flat washers, lock washers and nuts. The antenna will be front heavy at this point but the weight of the feedline, when attached, will cause it to be balanced. If using multiple antennas in an array, be certain all mounting plates are at the same location. When attaching the antenna to your mast, use the 5/16" U-Bolts, flat washers, lock washers and nuts. Once you have the U-bolts installed and the antenna mounted on your support mast and tightened, you can route your feedline along the mast and over to the driven element and connector. Dress the coax against the antenna boom and tighten the connector. Seal the connector body with several layers of good grade vinyl tape. Then apply a layer of butyl rubber antenna sealer or RTV over the tape. This will provide a good vapor barrier and ensure years of trouble free performance. The insulated design will make for a very long-lived antenna that will stand up well in harsh environments.

If you wish to check your work, now is the time to apply power to the antenna. Any work around RF energy should be done carefully. We do not recommend standing next to an antenna with many watts of 144 Mhz energy radiating around it. Using an antenna analyzer, VNA or low power transmitter and SWR bridge, adjust the shorting bars for minimum SWR. Always keep the shorting bars the same distance from the ends of the driven element. Generally, good wattmeters can reliably indicate SWR down to about 1.2:1. A high directivity bridge or coupler can increase accuracy, but 1.2:1 is more than adequate for any installation.

The aperture of this antenna is large enough so that you must elevate the antenna a minimum of about 10 feet or 3.0 m above the ground. Point the antenna so that there are no "reflectors" or obstructions for 100 feet directly in front of the beam. A better method would be to point the antenna straight up toward the sky. Support the antenna on a wooden or metal pole or tube and tie, or guy, the antenna boom with very light string or line. Now the driven element will be at T-arm level and ground effects are removed. Most locations are pretty clear straight overhead as well!

Install a short length of coax (1/2 wave is ideal... The antenna impedance will repeat each half wave from the antenna regardless of coax imperfections) between the coax connector and your bridge or wattmeter. If you utilize your 144 MHz transmitter as an RF source, apply power - observe the reflected power. Turn off the power and adjust the T-Match bars equally in small increments - 1/8" or 3 mm. is a good starting point. Apply power again and observe results. If it got better, keep going. If it degraded, change the direction of your T-Match movement program and recheck your SWR. At some point, you will observe a null in reflected power. When you have found it, mark the point on the driven element and tighten the screws on the shorting bars.

Over the years, performance can degrade due to oxidation. It is a good idea to spray your handiwork with a good grade of clear paint sealant. As a general rule, the slower drying sprays tend to be more enduring. Rustoleum "Clear Seal" or Krylon clear spray are recommended. A few light coats work better than one big one.

DO NOT, UNDER ANY CIRCUMSTANCES, APPLY ANY TYPE OF SEALANT OR COATING TO THE DRIVEN ELEMENT, T-ARMS OR CONNECTOR ASSEMBLY, OTHER THAN KRYLON® CLEAR COAT. ANY OTHER COATING WILL ADVERSELY AFFECT THE SWR AND VOID YOUR WARRANTY.

This will complete the assembly of your DSEFO144-12. The construction of this antenna will provide many years of consistent performance with no degradation of performance due to corrosion and weathering.

<i>Element Description</i>	<i>Element Length mm.</i>	<i>Keeper Half Length mm.</i>	<i>Boom Section</i>
Reflector	1044	501	Rear
Driven Element	955	n/a	Rear
Director #1	961	459	Rear
Director #2	938	447	Rear
Director #3	922	440	Rear
Director #4	912	435	Rear
Director #5	903	428	Center
Director #6	898	425	Center
Director #7	894	424	Center
Director #8	890	424	Front
Director #9	886	423	Front
Director #10	882	421	Front

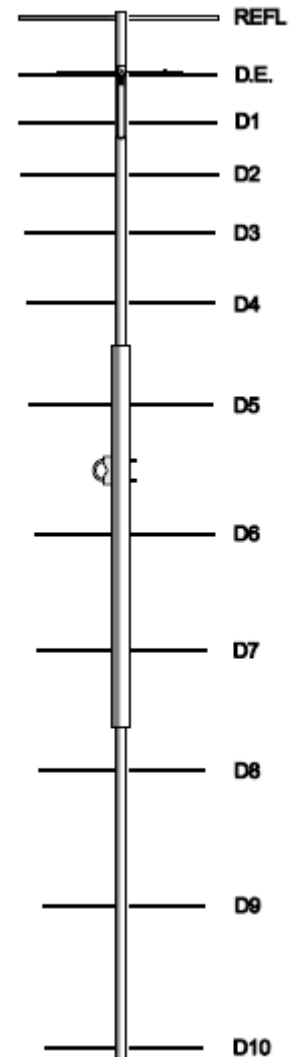

TABLE 1.
Lengths are +/- 2mm

Directive Systems Warranty Policy

All Directive Systems antennas are built with the finest materials available. We take great pride in building a quality product that will give years of good service and performance. If there is a defect in materials or workmanship within 90 days of purchase, Directive Systems will repair or replace the defective part, free of charge, to the original purchaser. **DO NOT RETURN ANYTHING WITHOUT PRIOR AUTHORIZATION FROM DIRECTIVE SYSTEMS.** Please contact us either by phone or email describing the problem and we will work to resolve it.

If, after examining a new antenna you received, you are not satisfied, contact us immediately for return authorization and refund. **ANY ANTENNA THAT HAS BEEN MODIFIED WILL BE SUBJECT TO A RESTOCKING CHARGE. IF AN ANTENNA IS SO MODIFIED AS TO MAKE IT UNUSABLE, DIRECTIVE SYSTEMS RESERVES THE RIGHT TO REFUSE TO ACCEPT THE ANTENNA FOR RETURN.**